



CONSTRUCTION MANUAL



www.seaperch.org



2700 South Quincy St., Suite 400, Arlington, VA 22206
www.seaperch.org

Welcome to your SeaPerch journey!

Today is an exciting one – today is the day you will embark upon your SeaPerch journey. I say journey because it is not simply a one-day experience you will have, or a short course you will take. We envision your participation in the SeaPerch Program as a step along a path that, we hope, will include other STEM (Science, Technology, Engineering, and Mathematics) activities. Think of SeaPerch as one step along the Yellow Brick Road that might lead you or your students to consider further study or a career in STEM.

SeaPerch is a K-12 Educational Outreach program sponsored by the Office of Naval Research (ONR) and managed by the Association for Unmanned Vehicle Systems International Foundation (AUVSIF), designed to help identify the next generation of STEM professionals. We are proud to be one of the Navy's signature Outreach programs. Over the past eight years, more than 250,000, yes that's a quarter of a million, students have participated in a SeaPerch build, and over 6,000 mentors and teachers as well.

We know SeaPerch to be an effective educational program and activity designed to teach and reinforce STEM concepts through hands-on activities and a STEM curriculum. With this one activity, students will meet many of the STEM national learning standards designated by the Department of Education. During the build and launch, students learn how to build a propulsion and electrical system, develop a controller, investigate density and buoyancy, use tools safely, and also learn how to work together as a team.

SeaPerch is designed to generate *Awareness, Interest*, and eventual *Pursuit* of STEM careers, and to teach students that working in a STEM field can be fun and engaging. The ultimate goal is that by participating in SeaPerch, awareness and interest in STEM will be ignited, resulting in some students deciding to pursue careers in technical, scientific, and research fields that will fill positions critical to the safety and security of the United States.

I encourage you to refer often to the www.seaperch.org website, as we have designed it to be a resource for your continued use. The discussion groups, training and build videos and manuals, curriculum, educational activities and lessons available on the website are continually updated. Our intent is for the website to be the main reference point for information that changes and updates frequently. Go! Take the first step on your SeaPerch journey, and have fun!

Susan Nelson
Executive Director, SeaPerch Program
AUVSI Foundation

UNIT 1 – ASSEMBLY OF SUBSYSTEM ONE -- THE VEHICLE FRAME

In this unit, you will cut pipe pieces and assemble the SeaPerch's frame. Holes will be drilled in the elbows and portions of the frames to allow venting and draining of the SeaPerch frame and motor mountings later in the build.



Tools and Materials Needed

Tools	Materials
Eye Protection (Always Worn)	72" (1.8 m) ½" PVC Pipe (Or Six, one foot. Lengths)
Ruler and Pencil (or Marker)	10 ½" PVC Elbows
PVC Pipe Cutter (or Saw)	4 ½" PVC Tees
Wire-Cutting Pliers (Flush-Cutting Type Preferred)	2 Floats
Electric Hand Drill	1 12" x 6.5" (31 x 17 cm) Payload Net
¼" Drill Bit	8 6" Tie Wraps (small black)
3/32" Drill Bit	

Procedure 1.1 – Cut the Frame Parts

Construction Steps:

1. Measure and mark the pieces listed below from lengths of ½" PVC pipe. Use a marker to write the length on the middle of each piece to keep track of cuts and to easily identify them later. Figure 1.1-1 shows the pieces needed to assemble the ROV frame. Figure 1.1-2 (on the next page) shows one way to cut the pipe pieces from six, one-foot pipes.

- Two** Pieces – **6.5"** (16.5 cm) long
- Two** Pieces – **4½"** (11.4 cm) long
- Two** Pieces – **2½"** (6.4 cm) long
- Four** Pieces – **5"** (12.7 cm) long
- Two** Pieces – **4"** (10.2 cm) long
- Four** Pieces – **1½"** (3.8 cm) long

2. Cut the longest pieces first, in case a mistake is made (smaller pieces can be cut from a mis-cut longer piece). Try to cut *straight across* the pipe, but don't worry if they are not perfect.

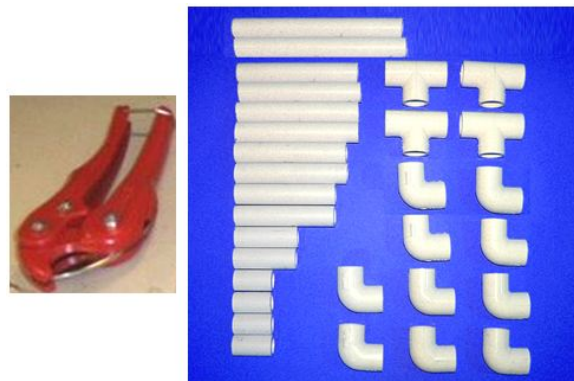

Figure 1.1-1: PVC Pipe Cutter and Cut PVC Pipe Sections, Elbows, and Tees

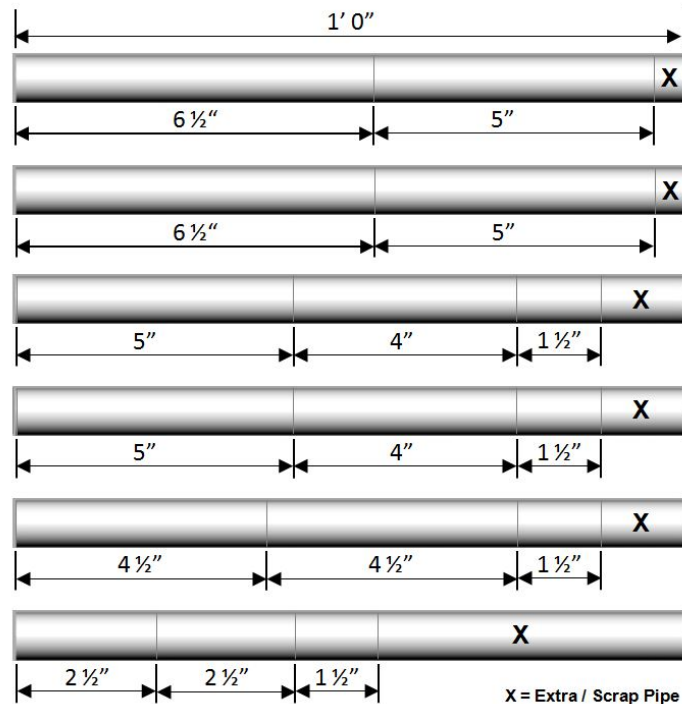

Figure 1.1-2: Cutting Guide to Efficiently Mark and Cut the 16 Required Pipe Sections from the Six One-Foot Pipe Pieces Provided in SeaPerch ROV Kits

Procedure 1.2 – Drill the Drain Holes

NOTE: You will need to create vent and drain holes in the vehicle frame in order to allow water to fill the frame when you place your SeaPerch into the water and for the water to drain out when you remove it.

Construction Steps:

1. Place an elbow on the end of a 6"-to-12" length of $\frac{1}{2}$ " PVC pipe, to use the pipe as a handle while drilling, as in Figure 1.2-1, or secure it in a vise or clamp.
2. Drill from the *interior* of the elbow outward, to avoid slipping. Drill a $\frac{1}{4}$ " hole in the corner of the elbow, such as shown in Figures 1.2-1 and 1.2-2.
3. Repeat Steps 1 and 2 for other PVC elbows.
4. Drill thruster mounting holes in two of the 5" lengths and one of the $4\frac{1}{2}$ " lengths as shown in Figure 1.2-3. Be sure to carefully center the thruster-mounting holes on that pipe so that the thrusters will be straight when mounted on the vehicle.

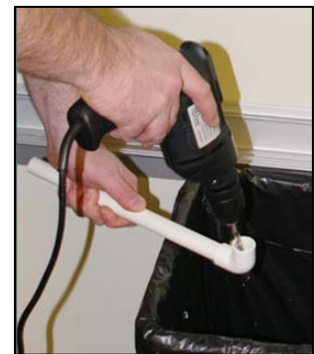
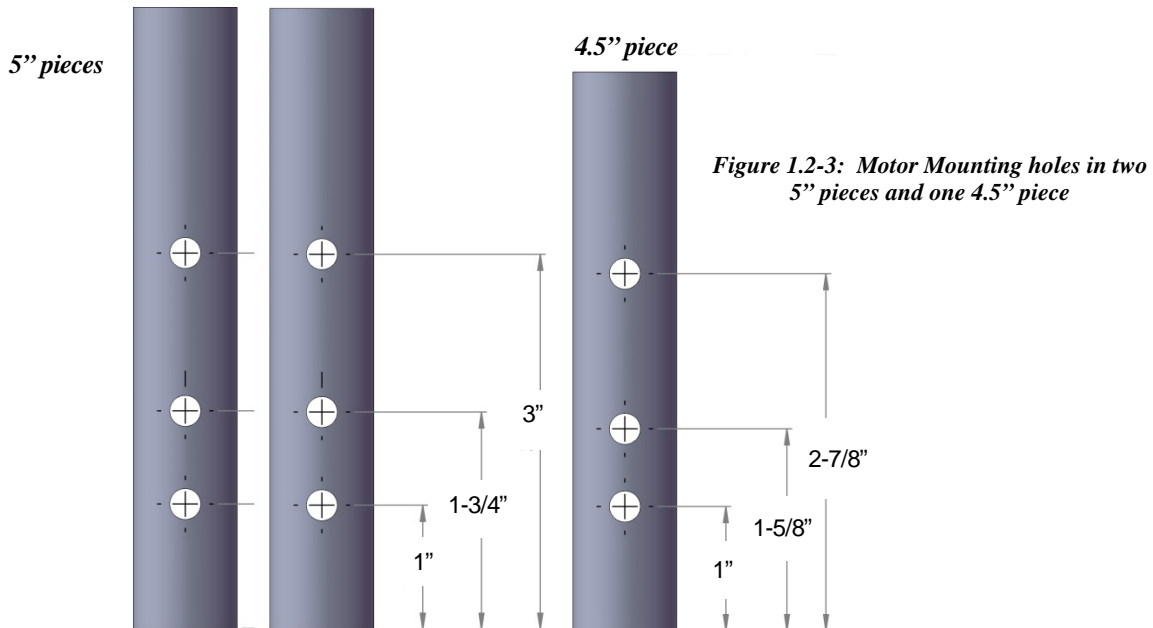

Figure 1.2-1: Drilling Elbow Hole over a Wastebasket



Figure 1.2-2: Drain Hole Drilled in a PVC Elbow



Procedure 1.3 – Assemble the Vehicle Frame

Construction Steps:

1. Assemble the frame using the PVC parts as shown in Figure 1.3-1. No glue is used for any of the connections. Orient the elbows that are near the top of the vehicle with their holes pointing upward, to let air escape when the SEAPERCH is placed in the water. Orient those at the bottom with their holes pointing downward or to the side, to let the water flood in and out easily.
2. Slide the foam floats onto each of the horizontal pipes on the top of the frame as shown in Figure 1.3-2.
3. With the frame placed on the floor or on a sturdy tabletop, push down hard on all parts of the vehicle frame, turning and pressing from all sides, so that the PVC fittings and pipe sections all fit together very tightly. **Be sure to press HARD, or use a rubber mallet to firmly tap on all elbows until the ends of the pipe sections bottom out inside the pipe fittings.** Adjust the sides and the bottom of the frame as needed to square up the vehicle, as shown in Figure 1.3-2 (or tilt the sides at an angle if you wish!). **It is important to do this before installing the bottom payload netting.**

NOTE: If you wish to paint your vehicle, do so before attaching the payload netting, flotation, or thrusters, and make sure to use waterproof paint.

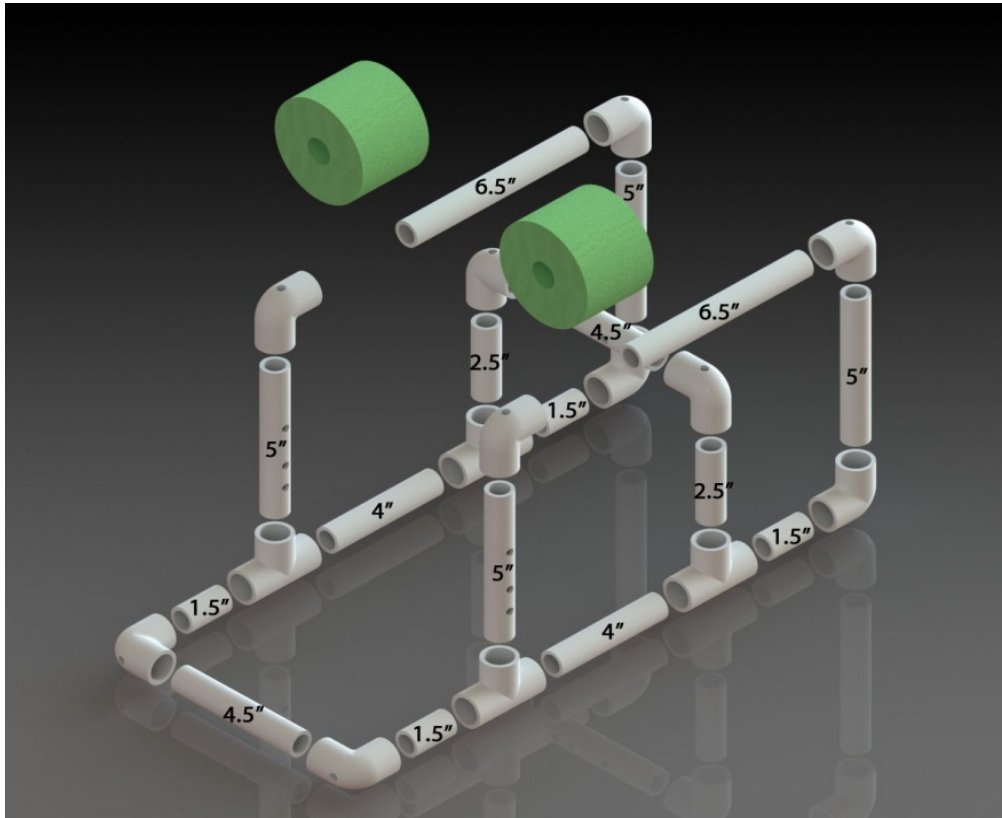

Figure 1.3-1: Initial Frame Assembly

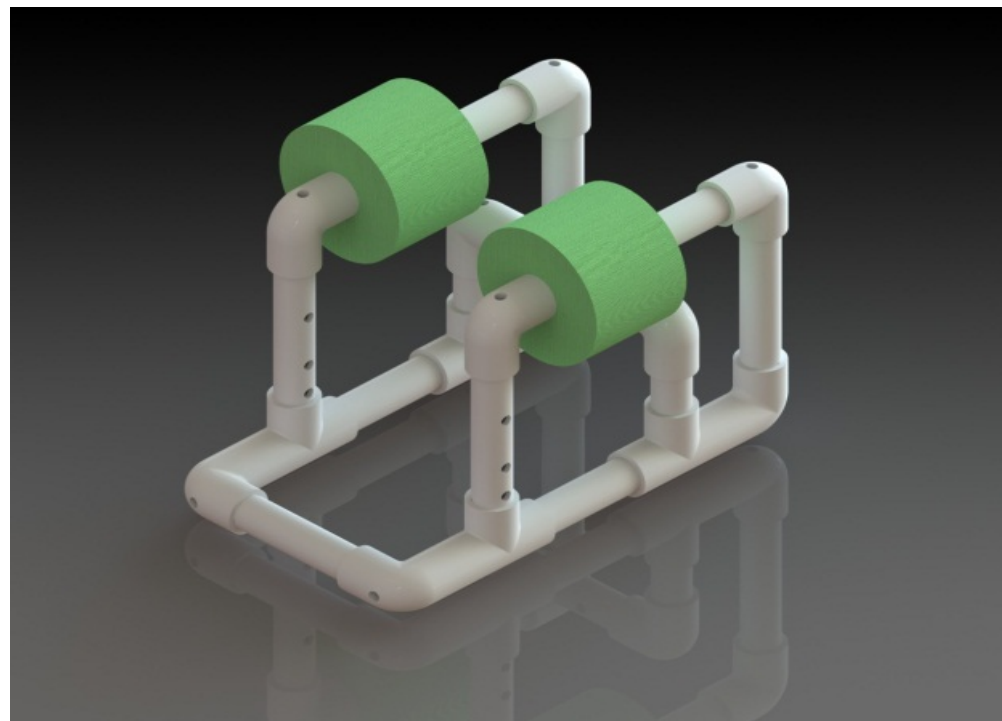

Figure 1.3-2: Assembled ROV Frame with Top Pipes and Foam Floats

Procedure 1.4 – Attach the Payload Net

Construction Steps:

1. Place the payload net underneath the vehicle frame, and use scissors to trim it to size.
2. Attach the net to the frame using about 8 small black tie wraps. Pull them tight using pliers. Make sure the net is tight and flat on the bottom of the SeaPerch.
3. **DO NOT USE THE LARGE BLUE TIE WRAPS FOR THIS**
4. Trim off the ends of the tie wraps using wire-cutting pliers (as flush as possible), as shown in Figure 1.4-1.

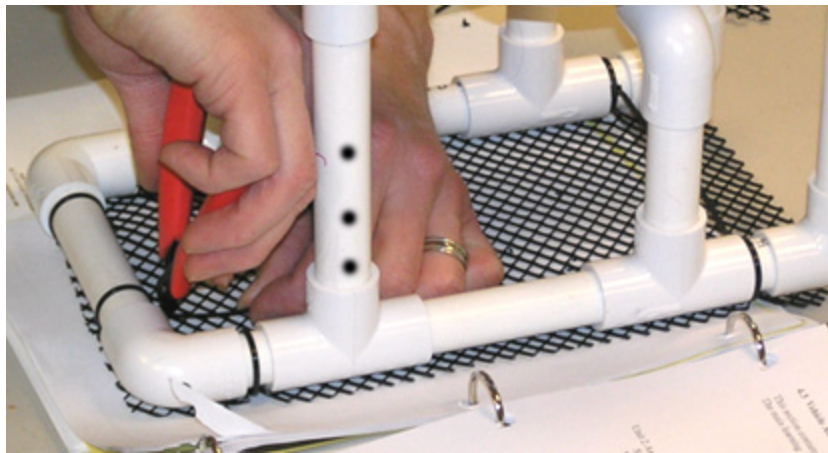
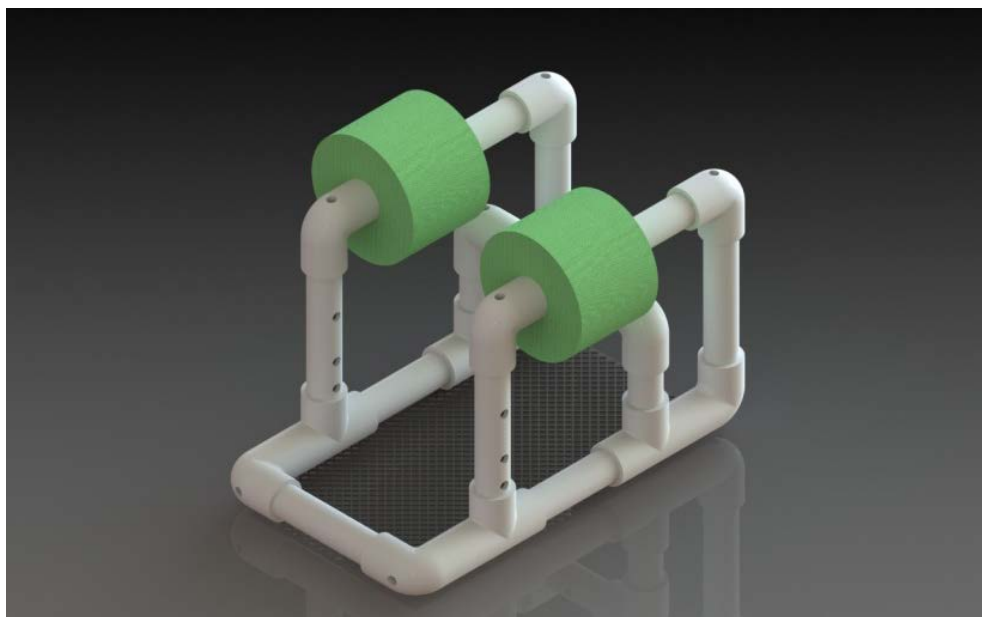

Figure 1.4-1: Payload Netting Attached to Frame

Congratulations! You have completed the frame for your SeaPerch!



UNIT 2 – ASSEMBLY OF SUBSYSTEM TWO -- *THE THRUSTERS*

In this unit, you will waterproof the motors using wax, install propellers, waterproof the tether cable and mount the thrusters onto the frame.



Tools and Materials Needed

Tools	Materials
Eye Protection (Always Worn)	~50' (15 m) CAT 5 Tether Cable with RJ-45 Connector
Electric Hand Drill	Installed on One End
3/32" Drill Bit	3 35 mm Film Canisters, with Caps
1/4" Drill Bit	3 12-Volt DC Motors
Pliers	3 Die Cut Vinyl Tape Set
Needle-Nose Pliers	3 Propellers
Wire Stripper (18 - 26 AWG Size)	3 4-40 Threaded Propeller Shaft Couplers
Wire-Cutting Pliers	3 4-40 Tee Nuts
Vise	3 4-40 Lock Nuts
Permanent Ink Marking Pen	1 Super Glue
Ruler and Scissors	1/3 Wax Bowl Ring
Soldering Iron and Solder	1/2" Butyl Rubber Tape
Fine Sandpaper or Steel Wool	1 12-Volt Battery
Gloves (Disposable Type)	5 6" (15 cm) Tie Wraps (small black)
	6 11" Heavy-Duty Tie Wraps (large Blue)
	Alcohol Pads
	Paper Towels
	Electrical Tape

Procedure 2.1 – Seal the Motors So That Wax Cannot Get Inside

NOTE: The shell of each motor will be sealed with die cut vinyl tape to water-proof and wax-proof the insides. EVERY hole in each motor's shell must be sealed, and any folds in the tape, where potting wax could pass through, must be avoided.

Construction Steps:

1. Each motor will require three pieces of tape: two circular pieces with two flat sides and a hole in the center; and a one inch rectangular piece. Peel these off with each step as needed.
2. Referring to Figure 2.1-1, begin adding the vinyl tape pieces.
 - First take one of the circular pieces of tape and place it on the end of the motor with the two terminals. Smooth out any bubbles or ripples in the tape until it lies flat on the motor, to create an air-tight seal.
 - Next take another circular piece of tape and place it on the shaft end of the motor, with the shaft through the center. Again, smooth out any bubbles or ripples.
 - Lastly, take the rectangular piece of tape and wrap it around the side of the motor, covering up all of the holes in the metal. **When you wrap the tape around the motor make sure the two ends DO NOT meet over any of the holes.** Again, make sure there are no bubbles in the tape.
3. Repeat this taping process on each other motor.



Figure 2.1-1: Motor Taping Process

Procedure 2.2 – Drill Holes in the Thruster Housings

Construction Steps:

1. Before drilling the caps and thruster housings, scrape off any plastic lumps that may be in the drilling area, using your fingernail or a small tool.
2. Using the 3/32" drill bit, slowly drill a hole through the center of each of the three thruster housing caps, as shown in Figure 2.2-1.
3. *Very carefully* drill a 3/32" hole through the center of each thruster housing. Make sure the drill is held straight so that the hole is not on an angle.
4. Remove any plastic burrs from the holes in the bottoms of the housings that may be left after drilling. Do this by removing the 3/32" drill bit from the drill and passing it slowly by hand straight through the holes, from both directions, a few times, *without twisting*.



Figure 2.2-1: Holes Drilled in Thruster Housings



Procedure 2.3 – Connect the Tether Cable Wires to the Motors

NOTE: Each motor must be connected to one of the color-coded pairs of wires in the tether cable. The CAT 5 tether cable has four wire pairs inside. The brown wire pair is not utilized for the SeaPerch. The other three of them will be used for the standard SeaPerch.

Construction Steps:

1. On the end of the tether cable that has no connector installed, use scissors to slit open the outer jacket and expose the first inch of wires as shown in Figure 2.3-1
2. Then pulling the brown pair of wires tear the jacket back about 15" (38 cm) as shown in Figure 2.3-2 and Figure 2.3-3
3. Trim the torn cover off being very careful not to nick any of the wires as shown in Figure 2.3-4
4. Remove the brown wire pair by cutting them using the wire strippers.
5. Run about 1" (2.5 cm) of each wire pair through the hole in a thruster housing cap, and tie a knot on the inward side of the caps, as shown in Figure 2.3-5.
6. Using the wire strippers, strip about 1/4" of insulation from the end of each wire, for the green, blue, and orange pairs.
7. Select a pair of wires and one of the taped motors. Twist the solid color wire through the positive terminal marked earlier. The striped wire attaches to the other terminal. Bend the stripped end of each wire through the terminals, and squeeze the wire tightly onto it as shown in Figure 2.3-6.
8. Solder the wires onto the two terminals of the motor. **NOTE: Soldering guidance can be found on page 29.**
9. **Repeat** for the other motors and their tether wire pairs.

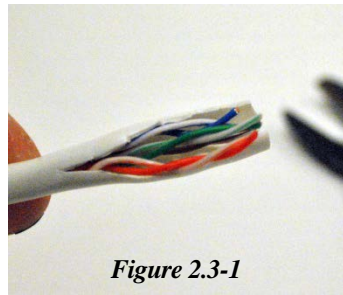

Figure 2.3-1

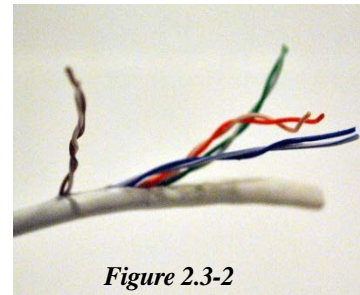

Figure 2.3-2

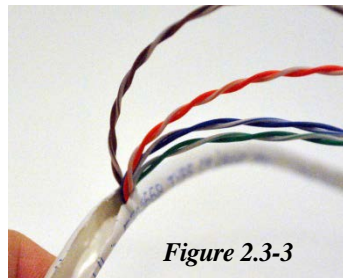

Figure 2.3-3

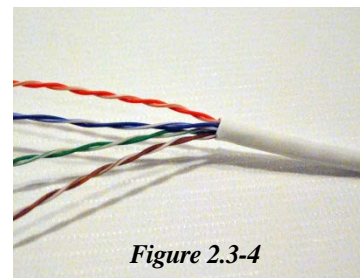

Figure 2.3-4

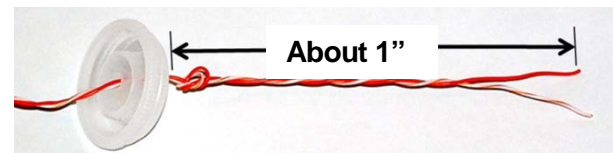

Figure 2.3-5: A Motor's Wires Passed through a Thruster Housing Cap and Knotted

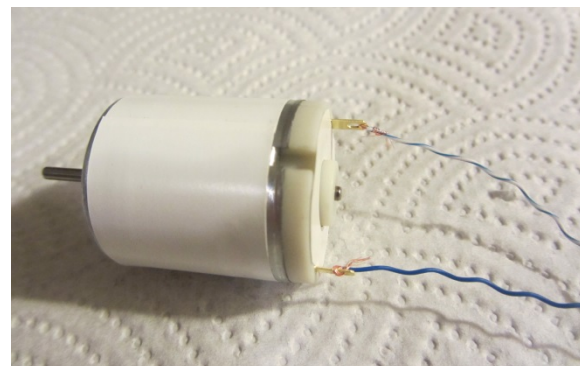

Figure 2.3-6: Tether Cable Wires Soldered Onto a Thruster Motor's Terminals

Procedure 2.4 – Pot (Waterproof) the Motors with Wax

Construction Steps:

1. Roll an acorn-size ball of wax in your gloved hands for a minute or so until it is softened, as shown in Figure 2.4-1.
2. Push and flatten the hand-warmed ball of wax to about a 1/4" thickness across the end of the motor and out to the diameter of the motor, as shown in Figure 2.4-2.
3. Insert the coated motor into the thruster housing, until the shaft pokes through the hole in the bottom of the housing, as shown in Figure 2.4-3.
4. Press firmly on the back of the motor to slowly move it to the bottom of the housing while the wax in the bottom pushes up around the motor until the shaft **fully protrudes** from the bottom, as shown in Figure 2.4-4.
5. Coil the wires into the end of the housing and press a marble-sized piece of room-temperature wax on top of the coiled wires to hold them in place, and then press the wax down to fill in any remaining space around the sides of the motor. Adjust the amount of the wax to fill the remainder of the area at the top of the housing, leaving just enough space for the cap to go on, as shown in Figure 2.4-5.
6. Move the lid onto the housing, as shown in Figure 2.4-6, and press hard to seat it into place. Then use a paper towel or baby wipe to wipe all waxy residues from the outside of the housing and the motor shaft.
7. Repeat for the other thrusters.

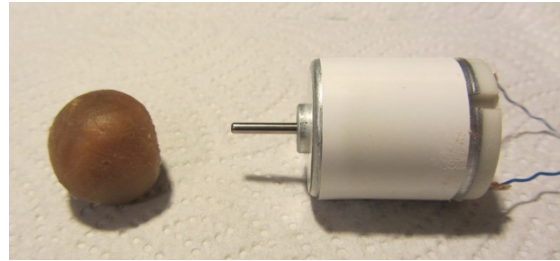

Figure 2.4-1



Figure 2.4-2

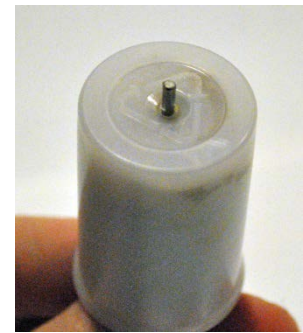

Figure 2.4-3



Figure 2.4-4



Figure 2.4-5



Figure 2.4-6

**STOP AND WAIT
FOR FURTHER INSTRUCTIONS**



Testing:

1. If a pre-made, "known-to-be-good" control box is available, test the thrusters by attaching the tether cable's RJ-45 connector to the control box. Press each switch, one at a time, and observe the operation of each thruster motor.
2. *The motor shaft should spin rapidly, indicating that the thruster is good.*

- *If a motor does not spin, or spins slowly, gently twist it in both directions by hand, or if it seems stuck, use pliers to turn the shaft, and repeat the test.*
- *If it still does not work, inspect the wires for nicks that may have broken a wire. Repair a break by stripping ¼" of insulation from the ends and splicing them back together (twist the wires, solder, and cover the connection with electrical tape).*
- *If the thruster still does not work, it may have a broken wire inside the thruster housing. The thruster can be opened to see if a wire may have broken away from one of the electrical terminals on the motor. Wax can be removed from the back area of the housing to allow the connection to be repaired, and then the wax and cap can be replaced.*
- *Test repaired thrusters as above to make sure that they spin properly.*

Procedure 2.5 – Mount the Propellers onto the Shafts

Note: The propeller mounting process can also be done at the end of Unit 2, after mounting the tether. This will allow the glue to dry without risking moving the propellers.

Construction Steps:

1. Wipe the shaft of each motor using a paper towel to remove excess wax that may be left after the potting process, as shown in Figure 2.5-1.
2. Use a small piece of sandpaper to roughen the surface of each of the motor shafts (this can be done by spinning the shaft against the sandpaper while turning on the thruster using a pre-made control box).
3. Then *wipe each thruster shaft again* with an alcohol pad.

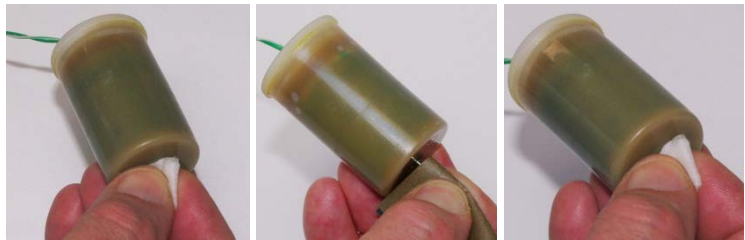

Figure 2.5-1: Cleaning, Roughening, and Re-cleaning a Motor Shaft

Cleaning the shaft is critical in order for the adhesive to stick to it!

4. Use a vise or pair of pliers to hold a threaded coupler, as shown in Figure 2.5-1.
5. Thread the tee nut, pointed-side up, all the way down the threaded coupler. A pair of pliers may be required to get the tee nut started on the threaded coupler, as shown in Figure 2.5-2 and Figure 2.5-3
6. Look closely at a propeller and note that one side has a slot (groove) in it, as shown in Figure 2.5-4. This is the side that must be placed nearest the motor. Place the propeller onto the threaded coupler with the slot side to the tee nut, as shown in Figure 2.5-5.
7. Thread a lock nut onto the threaded coupler, as shown in Figure 2.5-6.
8. Using pliers or ¼" nut driver, drive the assembly together by tightening the lock nut. A finished assembly is shown in Figure 2.5-7.
9. **Repeat** for the other propellers.

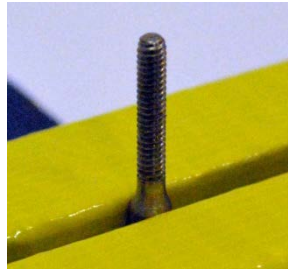

Figure 2.5-1



Figure 2.5-2

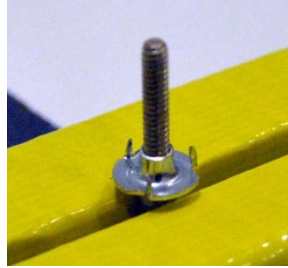

Figure 2.5-3



Figure 2.5-4

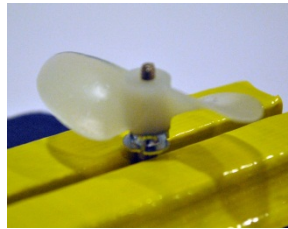

Figure 2.5-5

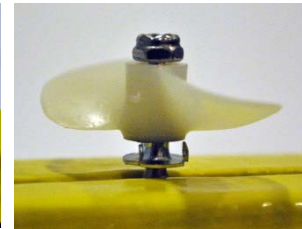

Figure 2.5-6

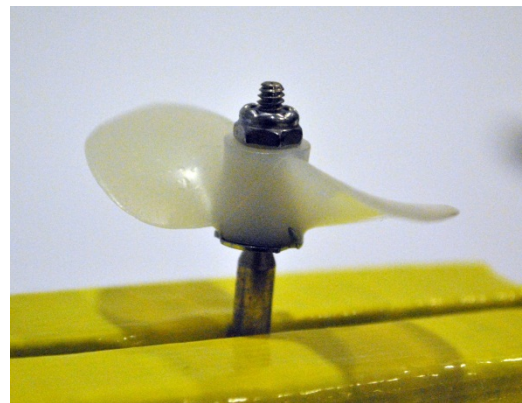

Figure 2.5-7: Finished Propeller assembly

10. Place a drop of Super glue in the hollow end of the shaft coupler and on the tip of the motor shaft, as in Figure 2.6-1. Push the hollow end of the shaft coupler onto the motor shaft. A completed thruster is shown in Figure 2.6-2.

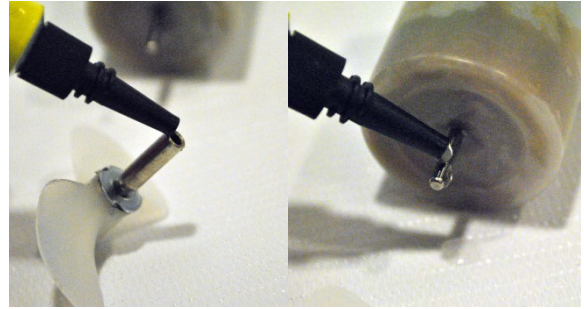

Figure 2.6-1: Adhesive on Tip of Roughened Motor Shaft and In Hollow End of Shaft Coupler

11. **Repeat** Step 8 for the other two thrusters.
12. Put your thrusters aside and allow the adhesive to harden, undisturbed, for 10 minutes to reach handling strength. Do not apply power to the motors or otherwise stress the glued connections until that time has passed.
13. After 10 minutes, turn each motor by hand to free up the newly installed assemblies.

Procedure 2.6 – Mount the Thrusters onto the Vehicle Frame

NOTE: The thrusters will each be held onto the ROV frame using two large blue heavy-duty tie wraps. To enable easy adjustment of the thruster pointing angles, an extra hole will be drilled in each pipe to which a thruster is mounted, enabling a screwdriver to be used to twist the pipe. The rear thrusters can be placed on the inside or the outside of the SeaPerch frame depending on your preference.

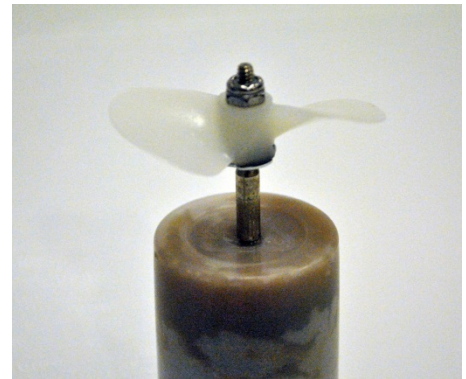

Figure 2.6-2: Propeller and Shaft Coupler Mounted on a Thruster Motor's Shaft

Construction Steps:

1. Thread a large, heavy-duty tie wrap through the two thruster-mounting holes at each of the three thruster locations, as shown in Figure 2.6-4.
2. Place the appropriate thruster in the loop formed by each tie wrap, and tighten the tie wrap around the thruster, as shown in Figure 2.6-5. Refer to Table 2.6-1 for thruster placement. Be sure to mount the vertical thruster with its propeller pointing upward, as shown in Figure 2.6-7.

Table 2.6-1 – Thrusters Identification for Placement on the Vehicle Frame	
Green / Green Striped	Starboard (Right)
Blue / Blue Striped	Port (Left)
Orange / Orange Striped	Vertical (up and Down)

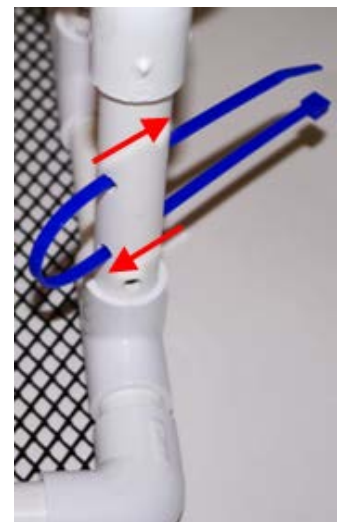

Figure 2.6-4: Tie Wrap Threaded Through Thruster-Mounting Holes

3. Install a second heavy-duty tie wrap *around* the first tie wrap, between the thruster and the pipe, at each of the three locations, and tighten each securely to hold the thrusters in place.
4. Cut off the tie wrap tails as flush as possible to avoid leaving sharp ends.

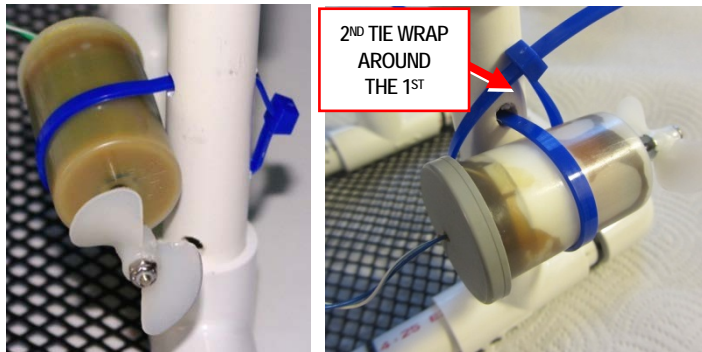

Figure 2.6-5: One Heavy-Duty Tie Wrap Holds the Thruster to the Pipe, and a Second Tie Wrap Tightens the First to Secure the Thruster Tightly to the Frame

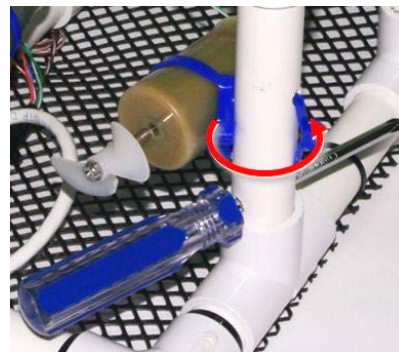

Figure 2.6-6: Thruster Angles Can Be Easily Adjusted By Inserting a Screwdriver into the Angle-Adjustment Holes and Twisting the Pipes

5. You can now use a screwdriver, inserted through the angle-adjustment holes, as shown in Figure 2.6-6, to gently turn the PVC pipes on which the thrusters are mounted so that the thrusters are oriented in the directions that you want.

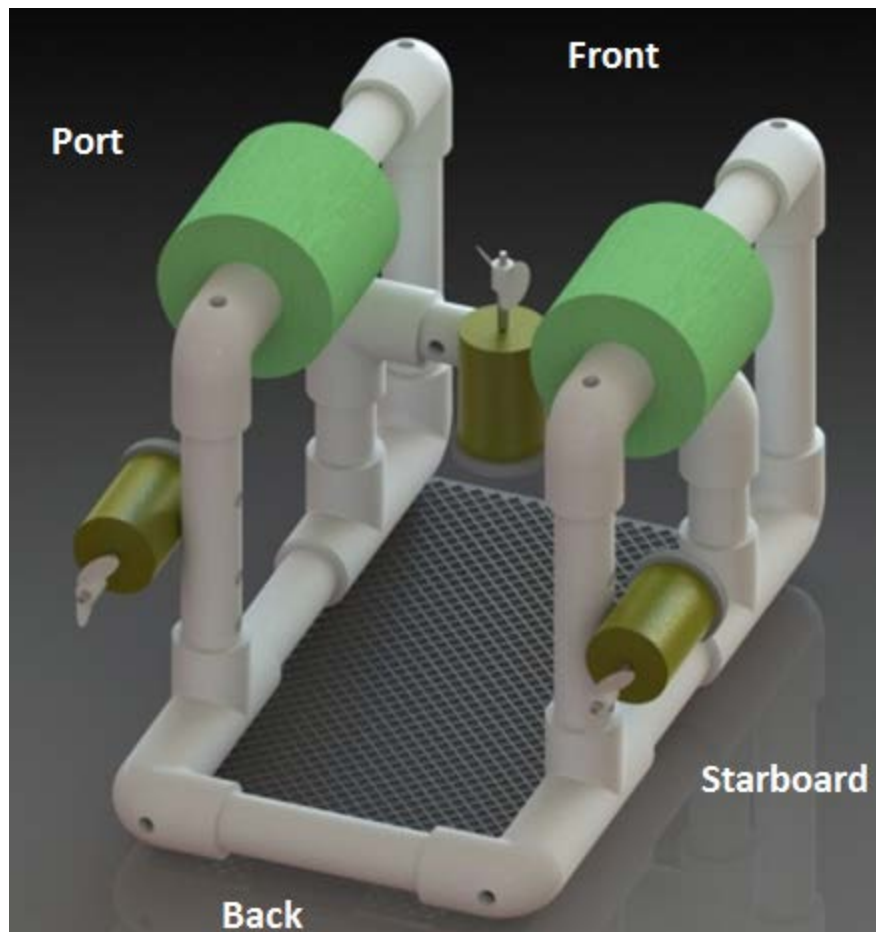

Figure 2.6-7: SeaPerch with Mounted Thrusters

Procedure 2.7 – Waterproof and Mount the Tether Cable

Construction Steps:

1. Using a ½" (1.5 cm) piece of butyl rubber tape, stretch the tape to about twice its relaxed length and wind it among and around the four wire pairs where they emerge from the outer jacket of the thruster end of the tether cable. Press it over the jacket opening so that it extends at least ½" on each side of the opening, as shown in Figure 2.7-1. Knead and work it in between the wires well so that it seals both around and between the wires and forms a smooth seal over the jacket opening to prevent water from getting inside the tether cable.

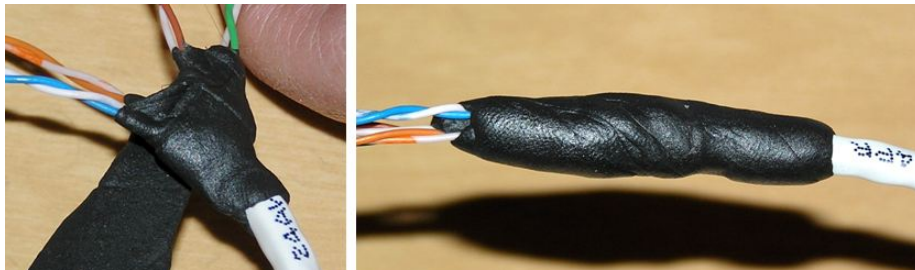

Figure 2.7-1. Butyl Rubber Tape Wrapped to Waterproof the Tether Cable Sheath's Opening

2. Wrap electrical tape over the butyl rubber tape to keep it from sticking to anything.
3. Install **two crossed tie wraps** to capture the tether cable where it passes over the **center** of the pipe at the rear of the ROV, as shown in Figure 2.7-2.
4. Coil the brown wire pair out of the way and tie-wrap it to the payload net.
5. Pull all tie wraps tight with pliers and trim the ends flush.

TIP: It is **important** to keep the tether cable **centered** and pointing **straight back** from the ROV so that its in-water drag does not tend to pull the ROV more to one side than the other, possibly making turning the ROV in one direction more difficult compared to the other direction. Don't forget to use two crossed tie wraps to help keep the tether cable straight.

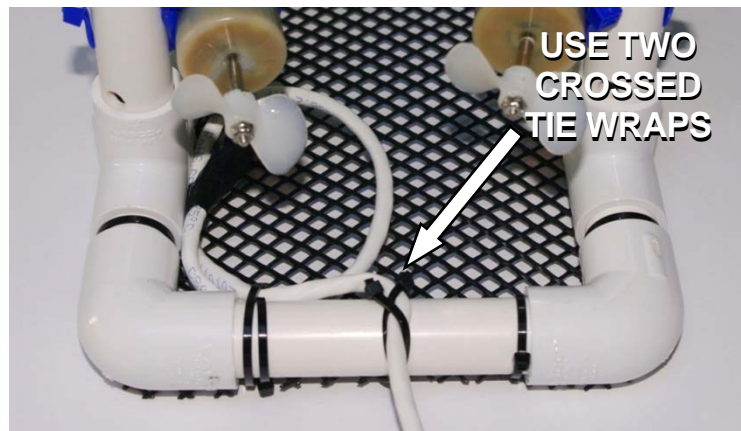

Figure 2.7-2. Tether Cable secured to the Frame and to the Payload Net with Tie Wraps

UNIT 3 – ASSEMBLY OF SUBSYSTEM THREE -- *THE CONTROL BOX*

In this unit, you will build the ROV's control box by mounting electrical components on a printed circuit board, assembling and connecting the power cord, and mounting the circuit board in the plastic control box.

NOTE: Soldering guidance can be found on page 29.



Tools and Materials Needed

Tools	Materials
Eye Protection (Always Worn)	ROV Frame with Thrusters and Tether Cable Installed
Ruler	1 Pre-Drilled Control Box with Lid and Screws (Black)
Scissors	1 Printed Circuit Board (PCB)
Pliers	4 PCB Mounting Screws (Silver)
Wire Stripper (18 - 26 AWG Size)	6' (~2 m) #18 Speaker Wire (Or Lamp Cord)
Wire-Cutting Pliers (Flush Type Preferred)	2 Alligator Clips (With Red and Black Covers)
Soldering Iron and Solder	1 Fuse Socket
#2 Phillips Screwdriver	1 6.3 Amp Fuse
	1 12-Volt Battery
	2 Double-Pole, Double-Throw (DPDT) Toggle Switches
	2 Single-Pole, Double-Throw (SPDT) Pushbutton Switches
	1 Type RJ45 CAT-5 Modular Connector Jack
	Electrical Tape

Procedure 3.1 – Gather the Parts for the Control Box Assembly

Construction Steps:

1. Gather, identify, and inventory the parts needed for the control box, as shown in Figure 3.1-1. Some parts, such as the switches, may look a bit different, but all types of items shown should be in the kit. If any are missing, notify your instructor who may have spare parts.
2. Locate the two toggle switches. If they have nuts and/or washers installed on their threaded mounting shafts, remove all nuts and the washers you will not need them; use pliers to loosen the nuts if needed.
3. Gather the eight small screws and put them in a safe place (such as taping them to the inside of the vehicle storage tote bag or bin) to prevent them from being misplaced during the assembly process.

TIP: It is important to follow the recommended order when adding components to the printed circuit board (PCB); otherwise it will be difficult to hold them in place while soldering. Use the sequence presented here for the easiest assembly. Remember, ALL of the parts go on the side of the PCB with the white lettering. If you look closely on the back of the board there is a message to help you to remember.

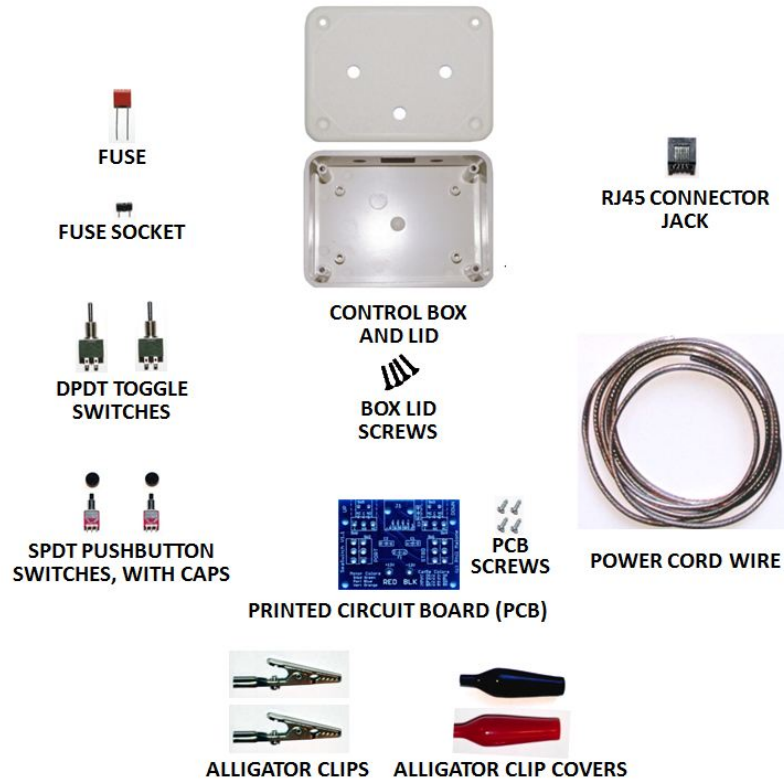

Figure 3.1-1: Electrical Components Required for the SeaPerch ROV Control Box

Procedure 3.2 – Assemble the Power Cord

Construction Steps:

1. Find the power cord wire, and determine which of its two conductors will be positive and which will be negative. For this project, we will call the copper side the **positive (+)** wire, and the silver side the **negative (-)** wire.
2. On each end of the wire, carefully separate the two conductors for a length of about 3 inches (7.6 cm).
3. Strip 5/8 inch (16 mm) of insulation off of all four ends of the power cord wire. Twist the strands on each of the ends (individually, not all together) tightly to prevent fraying.
4. On one end of the cord, slide the red alligator clip cover (small end first) onto the positive wire, as shown in Figure 3.2-1. Slide the black alligator clip cover onto the other (negative) wire of the power cord.

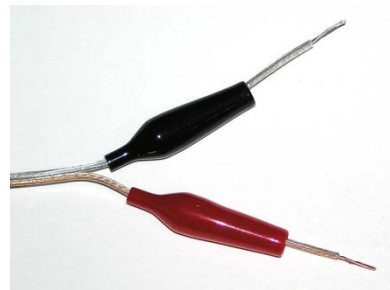

Figure 3.2-1: Alligator Clip Covers Installed on Power Cord Wires

- Attach the two alligator clips to the power cord wires by pushing the wires in through the backs of the clips and up through the holes near the screws. Loosen the screws, wrap the wires around them tightly in a clockwise direction, and then re-tighten them. The connected alligator clips should look like the one in Figure 3.2-2, with most of the wire captured under the screw's head.
- Move the covers over the clips (insert a pencil or other small object into the "mouth" of each alligator clip to make it easier to push the covers over the rear part of the clip). The finished power cord should look like Figure 3.2-3. Its other end will be connected to the PCB later, in Procedure 3.4.



Figure 3.2-2: Wire Properly Connected to an Alligator Clip Screw



Figure 3.2-3: Completed Power Cord

Procedure 3.3 – Install the Printed Circuit Board Components

Construction Steps:

DO NOT INSTALL COMPONENTS UNTIL IT IS CALLED FOR IN THE INSTRUCTIONS.

Review Figure 3.3-8 on page 21 if needed during the following assembly steps. The parts will be installed in order according to their size, smallest first.

- Locate the **fuse socket**. Place its two pins through the holes at the location on the board labeled "F1," as shown in Figure 3.3-1 (remember, **all** components go on the side of the PCB that has the white lettering). Use a small piece of electrical tape to hold the socket in place. Flip the board over and place it on a tabletop. Melt only about 1/4" of solder into each connection, let them cool for a few seconds before moving anything, and make sure that there are no solder bridges between the connections. (Remove excess solder if needed by touching the solder bridge briefly with a clean, hot, soldering iron tip.)

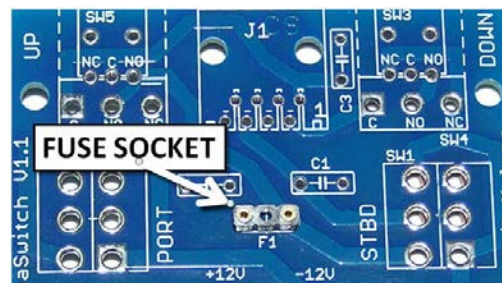

Figure 3.3-1: Fuse Socket Installed at the Location Labeled "F1"

- Place the pins of the two **pushbutton switches** through the pads in the PCB at the locations labeled "SW3" and "SW5," as shown in Figure 3.3-2, after making sure that their pins are all straight (perpendicular to the switch body). [You may have larger switches than shown, which fit instead into the other set of three holes at the "SW4" and "SW6" locations.] While holding the switches in place with a piece of electrical tape, flip the PCB over and place it on a tabletop. *Press down on the PCB to hold the switches flat against the board,* and solder all connections on each switch.

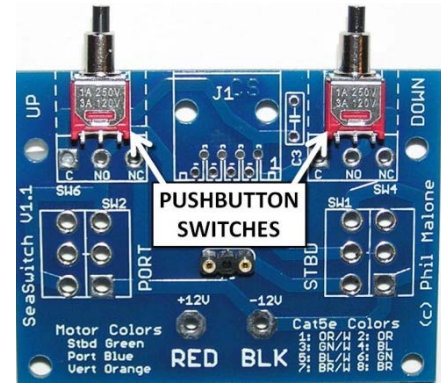

Figure 3.3-2: Pushbutton Switches Installed in the "SW3" and "SW5" Locations

- Find the two **toggle switches** and the **control box lid**. Place the switches in the "SW1" and "SW2" locations on the PCB, as shown in Figure 3.3-3. It is also important to keep these switches **flat** against the board while they are soldered into place, so that they will be straight when the control box is finished. A good way to do this is to use the control box lid to hold the switches while soldering. Put the toggle handles through the two center holes in the control box lid (they may be tight). Then, while holding the PCB against the back of the switches, turn the assembly over and place it across the open top of the control box, as shown in Figure 3.3-4. Hold the PCB down flat while soldering the first of the 12 switch connections, to make sure that it will be tight against the switches.

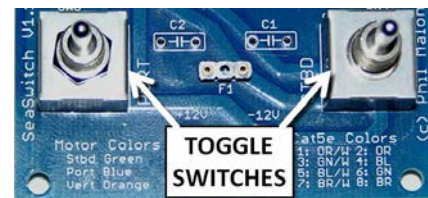

Figure 3.3-3: Toggle Switches Installed in the "SW1" and "SW2" Locations

- Solder the remaining 11 connections, taking care not to overheat the switches (wait a few seconds between connections, or alternate between the two switches). Then remove the nuts and the lid.
- Check the small pins on the bottom of the **RJ45 connector jack** to make sure that they are not bent, and then *carefully* put them through the PCB holes at location "J1," as shown in Figure 3.3-5. Press on the jack to snap it into place.



Figure 3.3-4: Toggle Switches Held Straight by the Control Box Lid During the Soldering Process

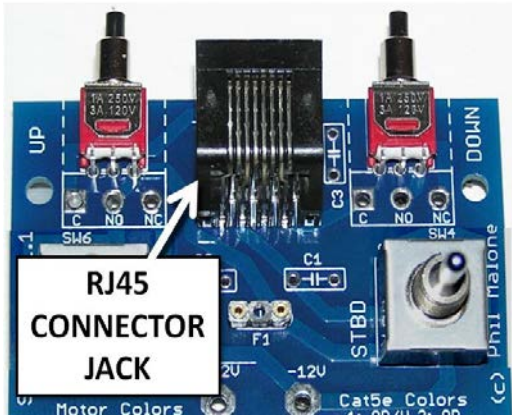

Figure 3.3-5: RJ45 Connector Jack Installed at Location "J1"

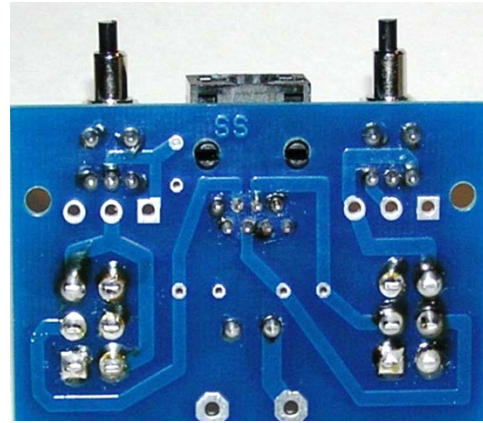

Figure 3.3-6: Bottom of a PCB after Soldering All Components

6. Place the PCB back on top of the control box, and solder the eight pins, being careful not to use too much solder, which might create solder bridges between the very-closely-spaced connections.
7. Re-examine all of the solder connections on the PCB as a final check for solder bridges or connections that don't seem to have enough solder. Re-solder them if needed. The soldered side of the completed PCB should look similar to the one shown in Figure 3.3-6. The completed PCB should look like Figure 3.3-7.

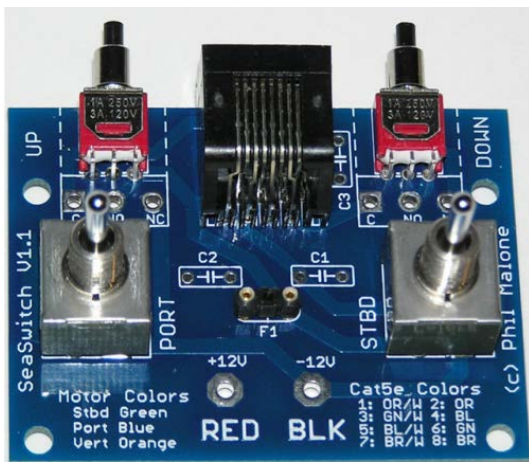

Figure 3.3-7: A Completed PCB

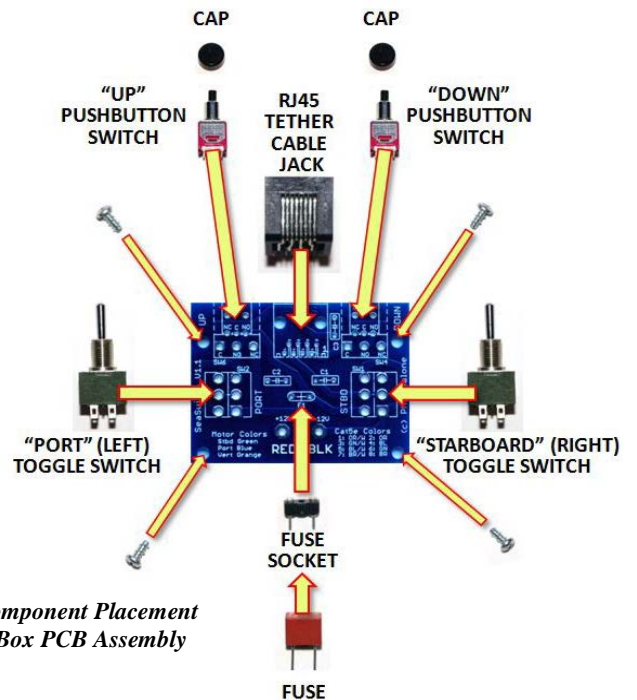

Figure 3.3-8: Component Placement for the Control Box PCB Assembly

Procedure 3.4 – Connect the Power Cord

Construction Steps:

1. Twist the strands of the two power cord wires, and **pass them through the cord hole in the control box lid, from the top side**. Then tie a knot in the two wires, about one inch from the ends, on the **underside** of the lid, as shown in Figure 3.4-1.
2. Re-twist the strands of each of the two wires so that they can pass through the PCB's solder pad holes, and place the positive (copper) wire into the "+12V" (RED) power wire hole, and the negative (silver) wire into the "-12V" (BLK) power wire hole, both entering the holes from the component side of the PCB, as shown in Figure 3.4-2. Bend the wires over to help hold them in place during soldering.
3. Solder the two power wires, using enough solder to make good, solid electrical connections. Then snip off the excess wire beyond the solder joints.



Figure 3.4-1: Power Cord Passed Through the Hole in the Box Lid, and Knotted

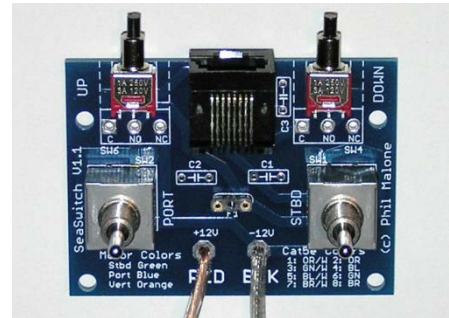

Figure 3.4-2: Power Cord Wires Through the Holes in the +12V and -12V Pads

Procedure 3.5 – Conduct Tests and Finish the Control Box

Construction Steps:

1. Locate the fuse. If its leads are longer than about ¼" (6 mm), cut both leads to that length, as shown in Figure 3.5-1.
2. Install the **fuse** into the fuse socket, as in Figure 3.5-2.
3. Locate a multi-meter with an "ohmmeter" function (measures electrical resistance) to conduct a few quick tests. These tests will tell you if there are soldering problems on the PCB (which can cause the fuse to blow and stop your ROV from working) or a switch problem. **DO NOT connect the battery** until the electrical testing in the following steps has been successfully completed. Set the meter to measure *resistance* (ohms), and make sure you can tell the difference between a "short" circuit (~0 ohms – touch the probes together) and an "open" circuit ("infinite" resistance – probes not touching). Some meters have a "beep" to indicate continuity, such as caused by a short circuit.
4. To test for shorts, connect your meter's probes to the two alligator clips on the power cord (the polarity of the leads does not matter). **Leave the tether cable unconnected.**
5. Now activate each of the four switches individually and in all combinations. **At no time should you get a low resistance reading (any continuity).** Try all switch combinations and make sure there is no combination that shows a short circuit. The meter should read infinite resistance at all times.
6. Then test the switches *with the tether cable connected*. You should see a low (NOT zero) reading of about 5 to 15 ohms whenever you activate any switch, as the meter shows the resistance of the coil of wire that is inside each of the motors. If you do not see such low readings for any engaged switch position, you may have a poor solder connection, a bad switch, a damaged wire or connector in the tether cable, or a thruster problem.

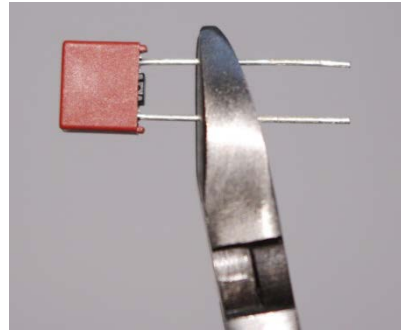

Figure 3.5-1: Cutting the Fuse Leads to ¼" Length

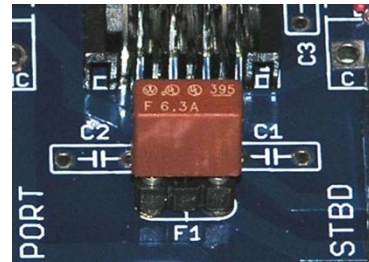

Figure 3.5-2: Fuse Installed in Fuse Socket

TIP: You may find it helpful to refer to the Troubleshooting Guide diagrams on Pages 27 and 28 if the tests in Procedure 3.5 identify possible electrical problems.

7. Once you are sure that there are no short circuits and that the thruster motors show proper readings, you can finish assembling the control box. Place the PCB into the control box, passing the pushbutton switch actuator buttons carefully through the two holes in the front of the box, and secure the PCB into the box using the four small silver screws, as shown in Figure 3.5-2.
8. Press the two pushbutton switch caps onto the actuator buttons, as shown in Figure 3.5-3.
9. Install the lid onto the control box, carefully folding the power cord wires inside the box as the lid is lowered into place. Secure the lid with the four black screws.
10. Connect the tether cable's RJ45 connector plug into the RJ45 jack on the control box.

CONGRATULATIONS, you have finished the construction of your SeaPerch ROV!

Now it's time to get it ballasted and try it in water!

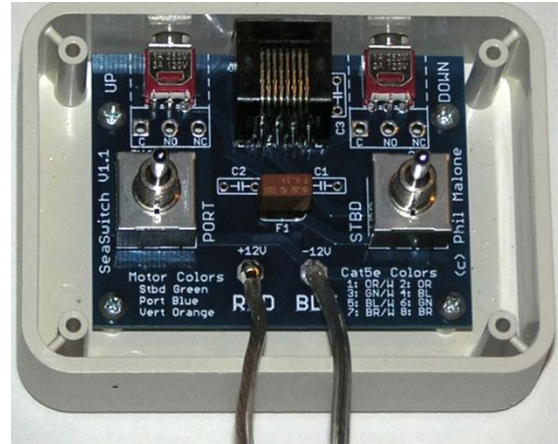

Figure 3.5-2: PCB Board Installed

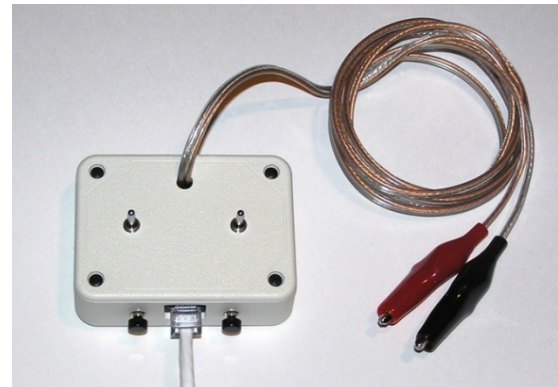
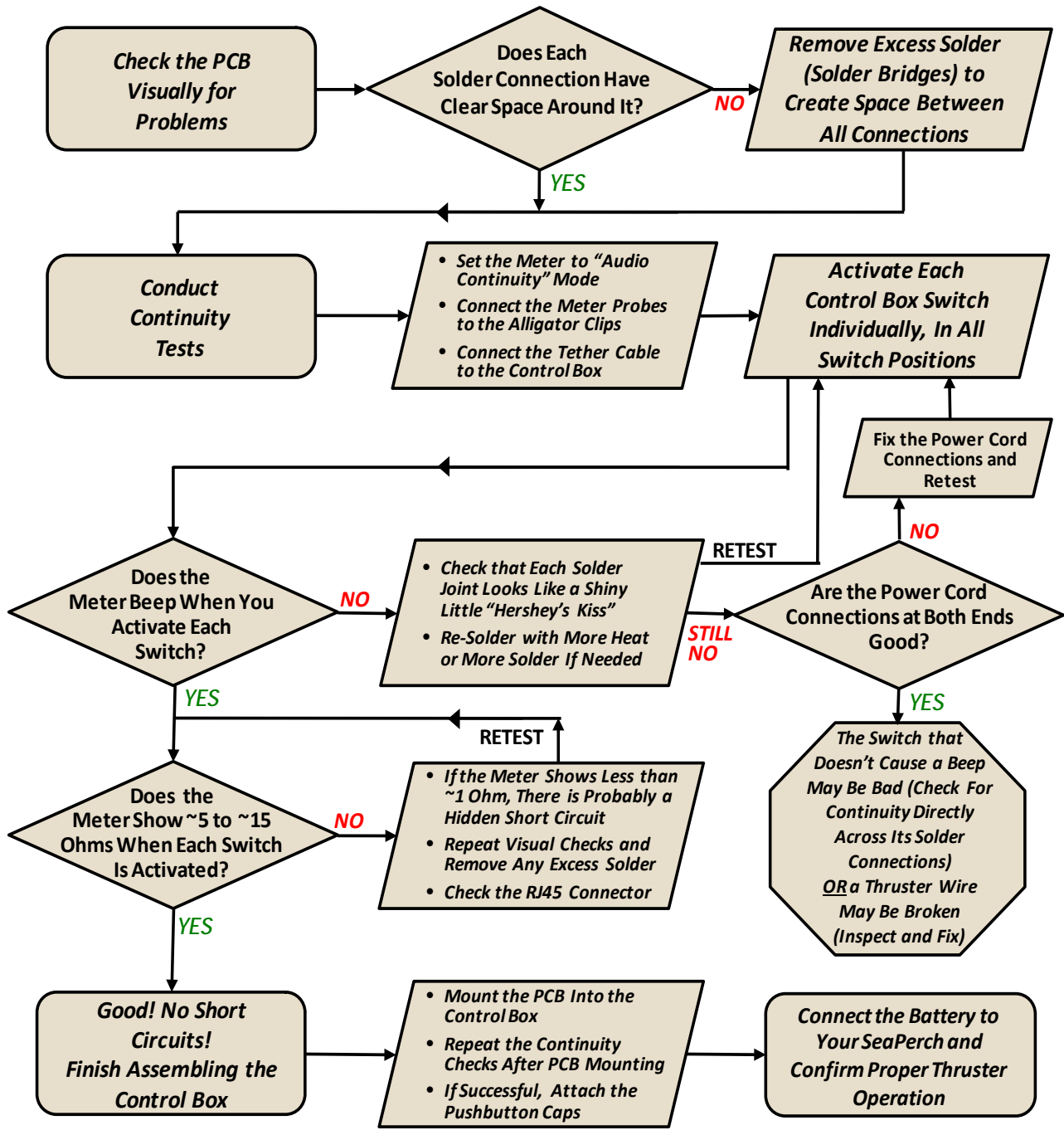

Figure 3.5-3: A Completed Control Box

CONTROL BOX TROUBLESHOOTING GUIDE

NOTE: This decision-tree style troubleshooting guide may be helpful in determining what is wrong when a SeaPerch control box does not function properly. The first section is for use with multi-meters that have an audio continuity-testing function. The second is for testing with an ohmmeter. Both tests should be done with the meter's leads connected to the power cord alligator clips.

Troubleshooting Testing Using an Audio Continuity Tester



Troubleshooting Testing With an Ohmmeter

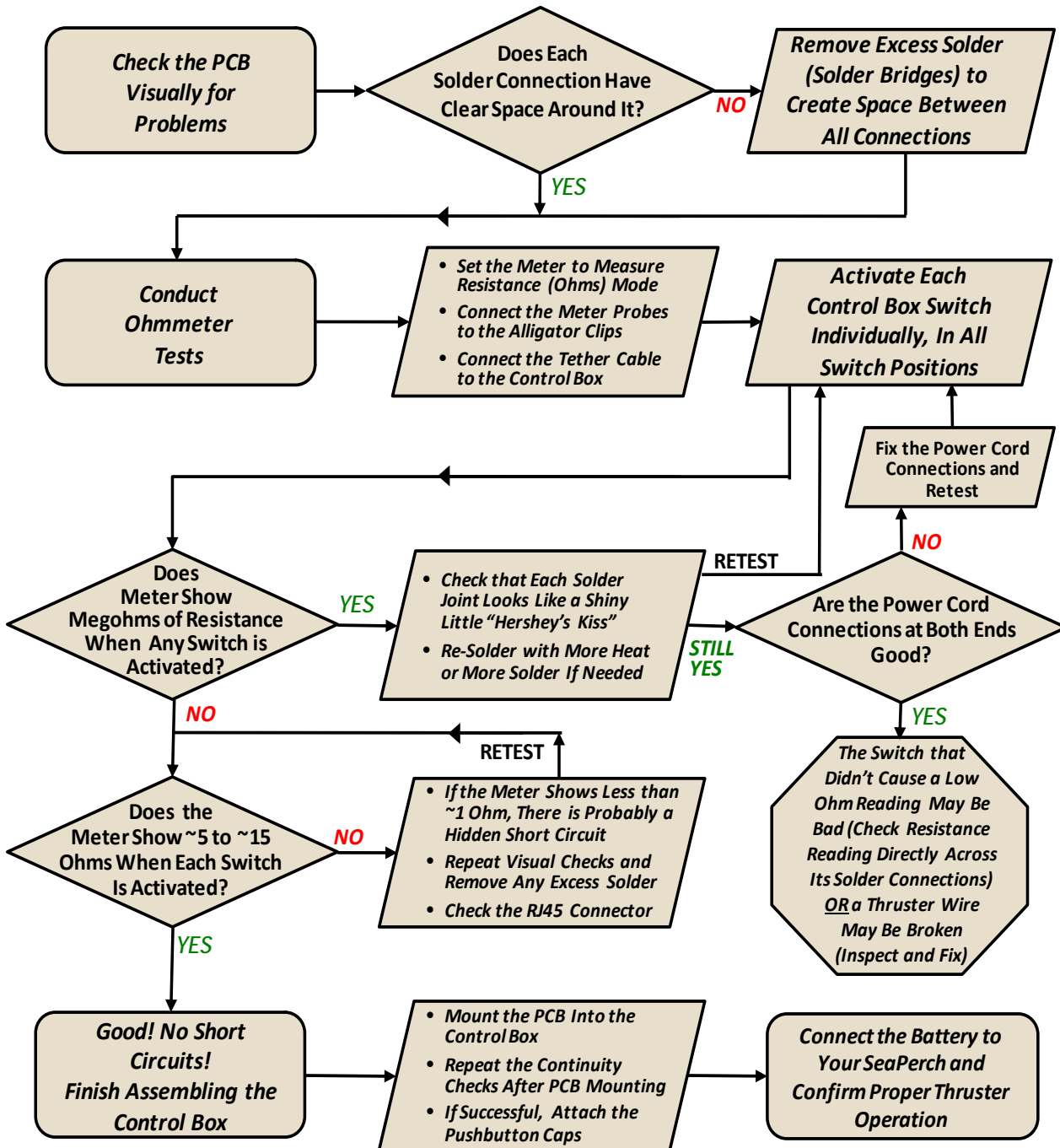

BALLASTING YOUR SEAPERCH ROV

NOTE: When using standard foam floats, their physical size will often decrease with increasing depth (over about six feet of depth) and they may absorb some water, due to increasing water pressure; this results in reduced displacement and thus reduced buoyancy at deep depths. For example, when the ROV is sent to the bottom at the deep portion of a swimming pool (often 12 feet or more in depth), it may no longer be able to return to the surface easily. For this reason, it is best to have the ROV ballasted to be more positively buoyant while at the surface when using foam style floats. This will also enable the foam-float-equipped ROV to more easily bring payloads to the surface.

Ballast and Trim Considerations for SeaPerch ROVs

The standard cylindrical foam floats that are supplied in SeaPerch ROV kits have a significant amount of buoyancy when in shallow water. This buoyancy must be counteracted by adding up to about 10 ounces or more of ballast weight in order to attain the near-neutral buoyancy preferred for ROV operation. If desired, the foam floats may be cut shorter by up to half their length, reducing the amount of often-expensive ballast items needed. Small slices of float material can then be used to adjust buoyancy.

Trim refers to fore and aft adjustments to the placement of ballast and flotation items on the ROV to make it level when submerged, which will enable the ROV to pick items up off the sea (or pool) floor as well as turn left and right without also changing depth. Standard SeaPerch floats are in fixed positions on the ROV, so proper trim is best achieved by minor adjustments to placement of ballast items, *after* neutral buoyancy is attained.

Different types of ballast materials may be used, but they should always be items that can be safely placed in water without damaging them (or the water). Also, for ballast to do its job well, it *should not move around*, which can change the ROV's trim and even its dynamics as it accelerates and decelerates. Therefore, bags of materials (which can also create excess drag) and suspended weights are not good choices for ballast.

Ballast items can be attached to the ROV in various ways, such as using tape, tie wraps, or fasteners such as screws or clamps. The weights can be attached to the frame or to the payload net; however, it is best to *keep the front center area of the net clear* to enable the ROV to pick up items without interference.

Attaching Ballast to the ROV

1. Place SeaPerch ROV in water (a large bucket or a deep sink, such as found in many school janitor's closets, will work if a large water tank or pool is not available).
2. Attach weights to the frame until the ROV is just slightly positively buoyant, meaning that it sits in the water with the floats just out of the water by about 1/4" (5mm) or less, and returns to the surface slowly if pushed underwater. Usually about 4 to 10 ounces (125 to 300 grams) is needed to achieve proper buoyancy. If your SeaPerch sinks without applying the downward thruster, it is too heavy. If your SeaPerch has trouble diving, or floats up to the surface very quickly, then it is too light.

USING YOUR SEAPERCH ROV

Safety Precautions

All ROV operators (pilot and tether manager) as well as water-side observers should exercise caution and stay aware of the movement of others while near the edge of the pool, dock, or other water-side location. Even simple inattention to what is going on in the area while focused on operating an ROV can lead to unexpected “dips.” Wearing a personal flotation device is recommended if operating the ROV from a pier that extends into deep water or from a boat (as is often required by law).

Batteries are heavy, and if one is pulled off a tabletop by a tug on the power cord, it can cause an injury (if dropped), as well as damage to the battery. Be careful in battery placement, by keeping it on the ground or pool deck.

Environments Suitable for Using a SeaPerch ROV

SeaPerch ROVs can be used in fresh water or saltwater, in man-made pools or natural marine environments. However, ballasting as well as post-operation cleaning requirements are different for the two types of environments. Due to the differing water densities, adjustments to the ballast, and to the ROV’s trim, are usually needed when moving from one environment to the other.

For deep water use, the foam floats (which change in buoyancy with depth) should be replaced with solid (non-compressible) floats.

Post-Run Cleaning and Maintenance of the ROV System

Post-Run Cleaning. The ROV should always be rinsed well with fresh water after use. Both pool water and saltwater can be corrosive to thrusters and metal parts. Biologic or other materials picked up in natural marine environments can be damaging and difficult to clean off later if left to dry on the ROV. Besides rinsing the vehicle and cleaning off any debris, it is helpful to submerge it in a tub of fresh water and run the thrusters a bit to better clear corrosive materials from the motor shafts. Allowing the vehicles to dry before storage is recommended. Even if the ROV will be disassembled to have its parts reutilized, having clean parts that are free from corrosive materials and contaminants is important. In such cases, the used thrusters can provide often-needed spares, so they should be cleaned carefully.

Battery Maintenance. Make sure to charge your battery after using it. Lead-acid batteries will last much longer if they are stored charged.

Enjoy Using Your SeaPerch ROV!

NOTES

TIPS: Soldering Iron Maintenance and Soldering Recommendations

1. Hold the soldering iron like a pen, not like a club, and rest your hand on a hard surface to engage your fine motor skills, for easier, more precise soldering than trying to guide the iron with your arm muscles.
2. When soldering, first heat the connection for a few seconds, with the side of the tip (not its smaller point), and then feed solder into the connection, not onto the tip. After the solder flows over the connection, remove the solder, wait a second or two, and then remove the soldering iron tip. Don't disturb the connection for several seconds while it cools and hardens.

TIPS – PCB and Component Soldering:

- When soldering, always use eye protection!
- Be sure that the components are placed firmly against the PCB before soldering them; although it is possible to make corrections later, it can be difficult.
- Clean the soldering iron tip before EVERY soldering step, and then touch solder to tip of the soldering iron to "tin" it briefly before starting to solder a component. Keep solder on the tip between uses.
- While soldering, touch the solder only to the "pad" (the round contact on the PCB) and the component wire or pin, not to the soldering iron tip.
- Touch the iron's tip only on the pads, not the board.
- Heat each connection for a few seconds before applying solder so that the solder will flow completely over the pad as well as the component wire that passes through the hole in the pad. However, do not overheat the pads, as they might lift off of the board or it may become scorched; several seconds of heating is usually enough.
- When done soldering, remove the solder from the pad first, then the iron.
- When soldering the switches, pause a few seconds between each connection, so that plastic parts inside the switches don't overheat and possibly get damaged.
- After soldering each connection let the solder cool for several seconds before moving the PCB, so that the solder will form a good conductive connection. They should be shiny, not rough or dull-looking; if they don't look shiny, simply reheat them and keep them still while cooling.
- Use just enough solder to cover the connection; too much can cause the excess to bridge between closely-spaced connections. Check for solder bridges after soldering each component.

NOTES

NOTES

The SeaPerch program website at <http://www.seaperch.org> contains valuable information and educational resources.